

GAS FIREBRICK® INSERTS : FOR FIREPLACES



QUADRA-FIRE

PURE PERFORMANCE



FEATURES AND CONVENIENCE

The Quadra-Fire FireBrick inserts offer more features than any other insert on the market today. A beautiful fire and log set are enhanced by an illuminated ember bed. Providing incredible heat efficiency, FireBrick technology combined with a powerful blower maximizes heat output and is easily adjusted with the full function remote control. Easily visible through the large viewing area is a customized sturdy grate with andirons. Four front options are available in several finishes to complete the gas FireBrick inserts and complement any room décor.

COVER: QFI35FB shown with Tuscan Bar front in Black with Antique Pewter accents.

ABOVE: QFI30FB shown with Firescreen Leaves front in Black.

GAS FIREBRICK INSERTS

QFI35FB

Offering a traditional masonry look and feel, the QFI35FB direct vent gas insert provides incredible heat efficiency. Combined with adjustable flame and heat output levels easily controlled by a standard remote control, the QFI35FB will complete any room with warmth and comfort. Top Right: QFI35FB shown with Firescreen front in Black.

QFI30FB

The QFI30FB direct vent gas insert features high efficiency and maximum heat output. Easily visible through the larger viewing glass is a beautiful and inviting fire with glowing log set. Four front options are available in several finishes to complete the QFI30FB and complement any room décor. Middle Right: QFI30FB shown with Firescreen Leaves in Black.

FEATURES & BENEFITS

- Patented FireBrick material delivers a realistic look, high efficiency, and quiet operation
- Flush hearth design gives the largest viewing area
- Large, realistic flame, glow and logs
- IntelliFire™ Plus advanced intermittent pilot ignition system eliminates the wasted fuel of a standing pilot system
- Standard, full function remote control makes all of the functions easy to use
- Standard blower to maximize your efficiency and heat output
- 50% turndown gives you control of the heat and allows you to enjoy the fire longer
- Illuminated embers come from within the fire adding realistic glow with or without the flame
- Fronts and low profile surrounds to fit any décor
- Customized sturdy grate with andirons



FIREBRICK TECHNOLOGY

Our exclusive FireBrick is constructed from a patented ceramic fiber material. Heat and compression are utilized to seamlessly mold uniquely shaped fireboxes with authentic brick patterns. FireBrick technology generates, retains and radiates significantly more heat into the room than a metal fireplace, while providing the warmth and glow of a real wood burning fire.





A NEW FIREPLACE IN FOUR EASY STEPS

- 1) Measure your existing fireplace
- 2) Choose your insert
- 3) Choose your surround
- 4) Finish with a front

QFI35FB shown with Firescreen front in Black.

GAS FIREBRICK INSERTS

STEP 1 MEASURE YOUR EXISTING FIREPLACE

We'll need the height, width and depth of the existing fireplace opening to ensure that the proper-sized insert is selected.

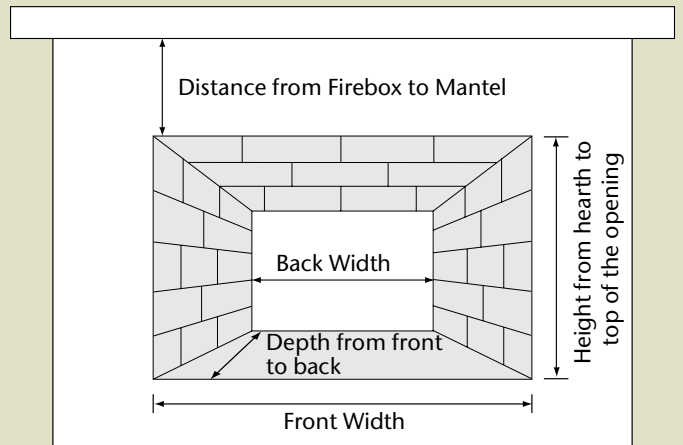

STEP 2 CHOOSE YOUR INSERT

There are two main factors to consider when selecting an insert. First, consider the height of your existing fireplace opening. You'll want to choose the tallest insert that will fit into your existing fireplace. Second, consider how the insert will be used. Do you have a large room, do you want a lot of heat or a little, and how long do you plan to run the fireplace? These answers will direct you to the insert that is ideal for you and your home.



QFI35FB

- Min. fireplace opening: 24-7/8" high
- Ideal size for larger firebox openings
- 35,000 Btu/Hr Input (NG)
- 7 split oak-style logs



QFI30FB

- Min. fireplace opening: 22-3/4" high
- Ideal size for smaller firebox openings
- 32,000 Btu/Hr Input (NG)
- 6 split oak-style logs

STEP 3 CHOOSE YOUR SURROUND

To bring a finished and polished look to your new insert, you need a matching metal surround to cover the gap between the insert and your existing fireplace opening. Offered in three standard sizes and two color options, including Black and Sienna Bronze, you're sure to find the perfect fit for your space.

SURROUND	QFI35FB	QFI30FB
Small	42" x 29"	40" x 27"
Medium	44" x 32"	42" x 30"
Large	48" x 32"	44" x 32"

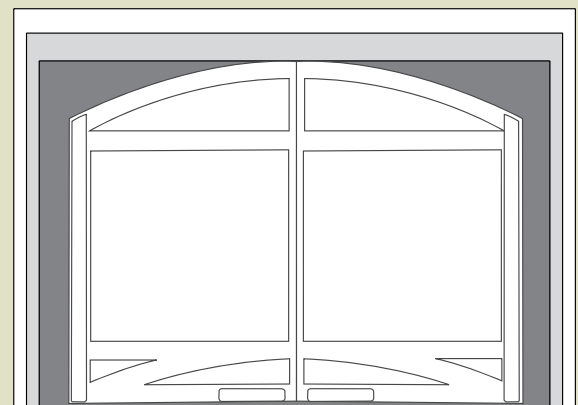

■ STANDARD SURROUND □ MEDIUM SURROUND □ LARGE SURROUND

GAS FIREBRICK INSERTS

STEP 4 FINISH WITH A FRONT

Complete your insert with a stylish front or operable door, available in various finishes and accents.



Tuscan Bar - Available in Black with Antique Pewter accents or Sienna Bronze with Antique Copper accents



Tudor Panel - Available in Black , Sienna Bronze, Black with Antique Pewter accents, or Sienna Bronze with Antique Copper accents



Firescreen - Available in Black or Sienna Bronze



Firescreen Leaves - Available in Black or Sienna Bronze

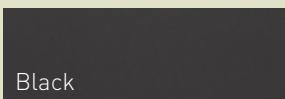

Black

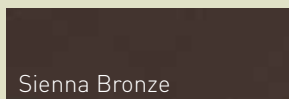

Sienna Bronze

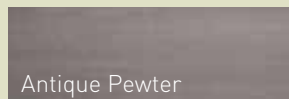

Antique Pewter

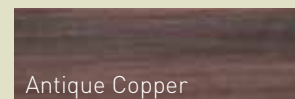

Antique Copper

EMBER LIGHTING

Highlighting the realistic features of the gas FireBrick inserts, unique ember lighting enhances the glowing logs and embers and can also be used when the insert is not in use to cast a warm glow into the room.



INTELLIFIRE PLUS IGNITION SYSTEM AND RC300 WIRELESS CONTROL



All Quadra-Fire gas inserts include the IntelliFire Plus ignition system to save fuel, improve efficiency and make your fire easier to use. The IntelliFire Plus Ignition System is an “intelligent” control system providing energy conservation and the comfort of a roaring fire, all at your fingertips! IntelliFire Plus features intermittent-pilot ignition (IPI) allowing you to conserve fuel and money when the fireplace is not in use. Optional constant pilot mode allows you to leave the pilot flame on in cold climates. In addition, the system offers seamless transition from AC to battery backup in a power outage, as well as built-in safety features and memory settings. Lastly, our new family of IntelliFire Plus wireless and ergonomic controls provides stylish and fully featured benefits that make controlling your heat easier than ever. IntelliFire Plus comes standard with all Quadra-Fire FireBrick inserts.

INTELLIFIRE PLUS RC300 The RC300 comes standard with all Quadra-Fire FireBrick inserts. and incorporates an LCD screen, intuitive menus and large control buttons in a sleek and modern design. This wireless control gives you the flexibility to use as a remote only or mount on the wall anywhere in the room.

MODEL: RC300-QDF

FEATURES: Auto Battery Backup, Pilot Activation, On/Off, 5 Step Flame Height, Fan Speed (Auxiliary 1), Two Additional Auxiliary Functions, Room Temperature Readout, Thermostat Mode, Timer Mode, Child Lock, Wall Docking Station



	GAS FIREBRICK INSERT SPECIFICATIONS					Performance		
	Technical Data							
	Shipping Weight	Flue Size	Ignition System	Mobile Home Approved	Bedroom Approved	Btu/Hr Input (NG)	Btu/Hr Input (LP)	Convection Blower
QFI35FB	140 lbs	3" x 3" Direct Vent	IntelliFire Plus	Yes	Yes	40,000 - 20,000	38,000 - 19,000	120 cfm
QFI30FB	105 lbs	3" x 3" Direct Vent	IntelliFire Plus	Yes	Yes	36,000 - 17,000	36,000 - 19,000	120 cfm

DIMENSIONS									
MODEL	FRONT WIDTH		BACK WIDTH		HEIGHT		DEPTH		VIEWING AREA
	UNIT	MIN. FIREBOX OPENING	UNIT	MIN. FIREBOX OPENING	UNIT	MIN. FIREBOX OPENING	UNIT	MIN. FIREBOX OPENING	
QFI35FB	34-3/4	35	25-1/4	25-1/2	24-5/8	24-7/8	17	18-1/4	31-1/2 x 20
QFI30FB	30	30-1/4	21-1/4	21-1/2	22-5/8	22-3/4	15-5/8	16-7/8	26-3/4 x 18

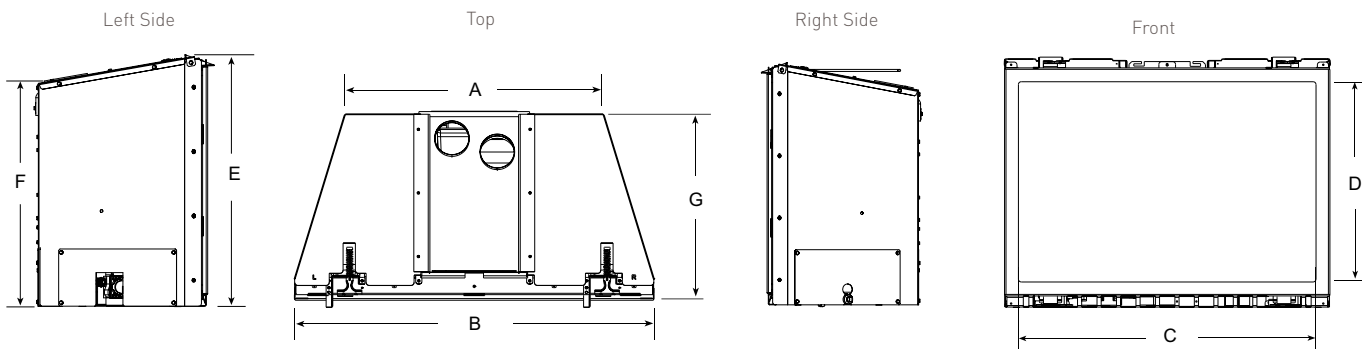

MODEL	A	B	C	D	E	F	G
QFI35FB	25-1/4	34-3/4	31-1/2	20	24-5/8	22	17
QFI30FB	21-1/4	30	26-3/4	18	22-5/8	20-3/8	15-5/8

CLIMATE ZONE MAP

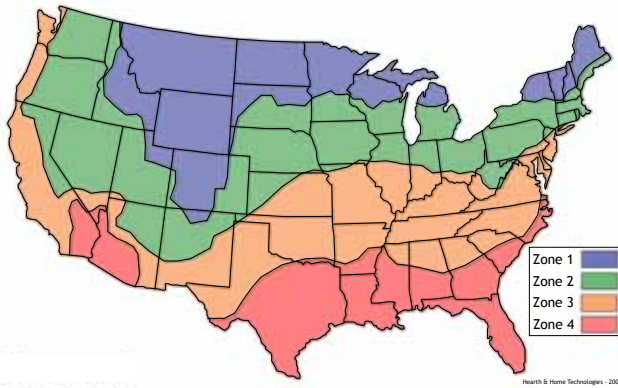

Heating Capacity by Climate Zone*

INSERT		ZONE 1	ZONE 2	ZONE 3	ZONE 4
QFI35FB	NG	1085	1265	1590	1985
QFI30FB	NG	940	1095	1395	1755

Zone measurements in square feet. Heating capacity (in square feet) is a guideline only and may differ slightly due to climate, building construction and condition, amount and quality of insulation, location of the heater, and air movement in the room. BTUs will vary depending on the type of fuel used.

GAS EFFICIENCIES

Steady State - Since most homeowners use their appliance for an extended time while they are in the room, Steady State measure how efficiently your appliance converts fuel to heat once it is warmed up and running in a "steady state".

AFUE - AFUE rating is more typically used with appliances, like your furnace, that continually cycle on and off to maintain a constant temperature.

EnerGuide (CSA P.4.1-02) - EnerGuide is a rating used in Canada to measure annual efficiency.

INSERT	U. S. EFFICIENCIES				CANADA ENERGUIDE	
	Steady State		AFUE		CSA P.4.1-02	
	NG	LP	NG	LP	NG	LP
QFI35FB	85.8%	86.0%	73.1%	73.8%	72.9%	73.8%
QFI30FB	85.8%	85.5%	70.1%	70.0%	68.8%	69.3%

QUADRA-FIRE[®]
NOTHING BURNS LIKE A QUAD

A brand of Hearth & Home Technologies[®]

1445 North Highway, Colville, WA 99114
www.quadrafire.com | 800-926-4356

Available From:

Limited Lifetime Warranty**

The strongest in the industry, Quadra-Fire provides a limited lifetime warranty on the most important aspects: firebox and heat exchanger.

** For full warranty details go to www.quadrafire.com

IMPORTANT - READ BEFORE YOU INSTALL!

Refer to the Owner/Installation Manual for complete clearance requirements and specifications. The images and descriptions in this brochure are provided to assist you in product selection only.

Quadra-Fire is a registered trademark of Hearth & Home Technologies. Product specifications and pricing subject to change without notice.

